

SUC 1000 E SU

Air-Intake

Only a mixture
between
Grain
and Air
can be
sucked

SUC

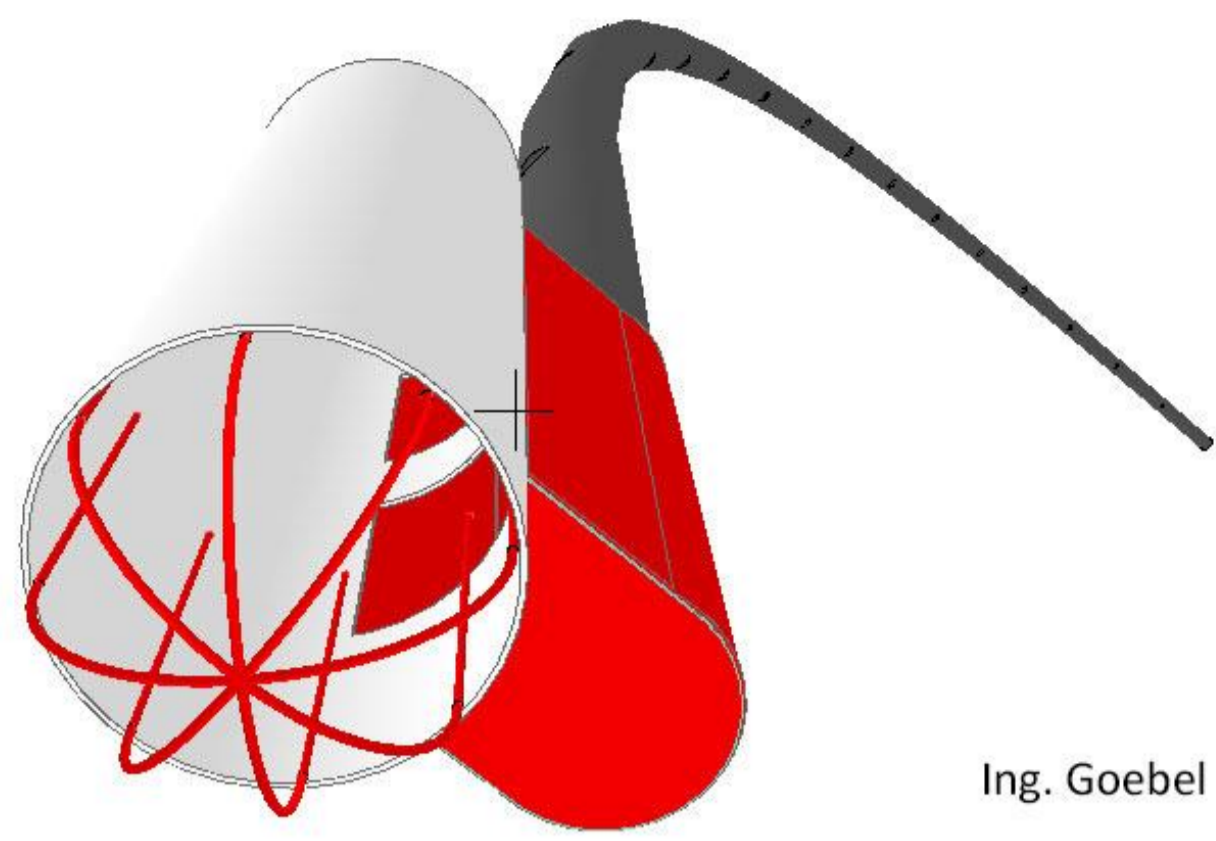

Ing. Goebel

SUC 1000 E SU

Air-Intake New

cut 01-01

measurement

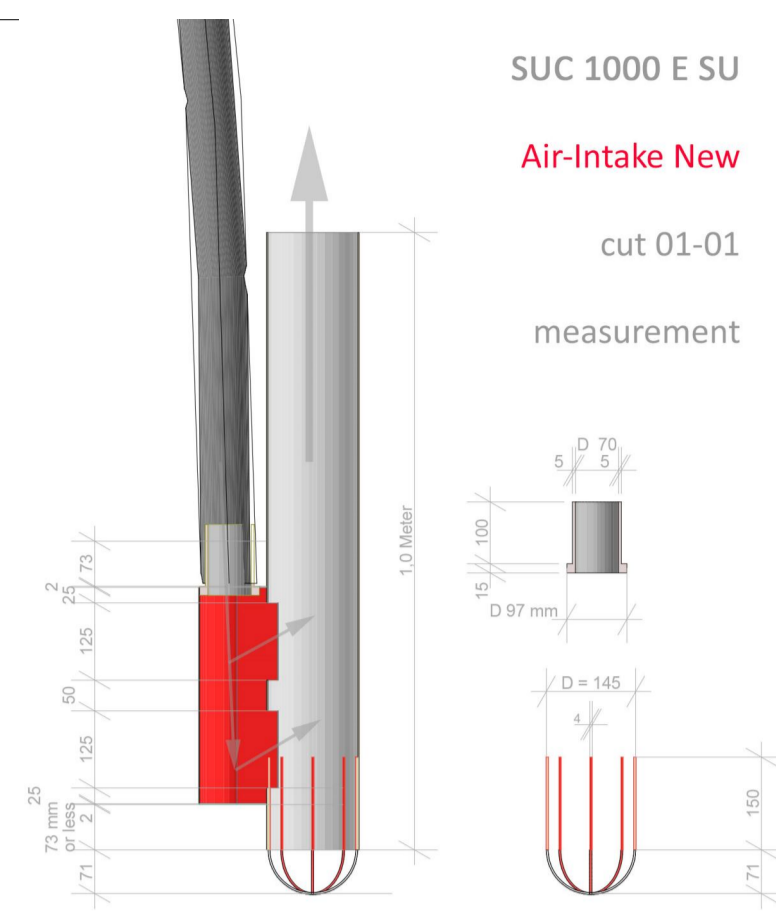

PE Hose (PE 100)

D outside 180 mm
wall thickness 10,7 mm
D inside 158,6 mm

Tube or whatever
D 150 -0/+1
thickness 4 mm

SUC 1000 E SU

Air-Intake New

Suction Head

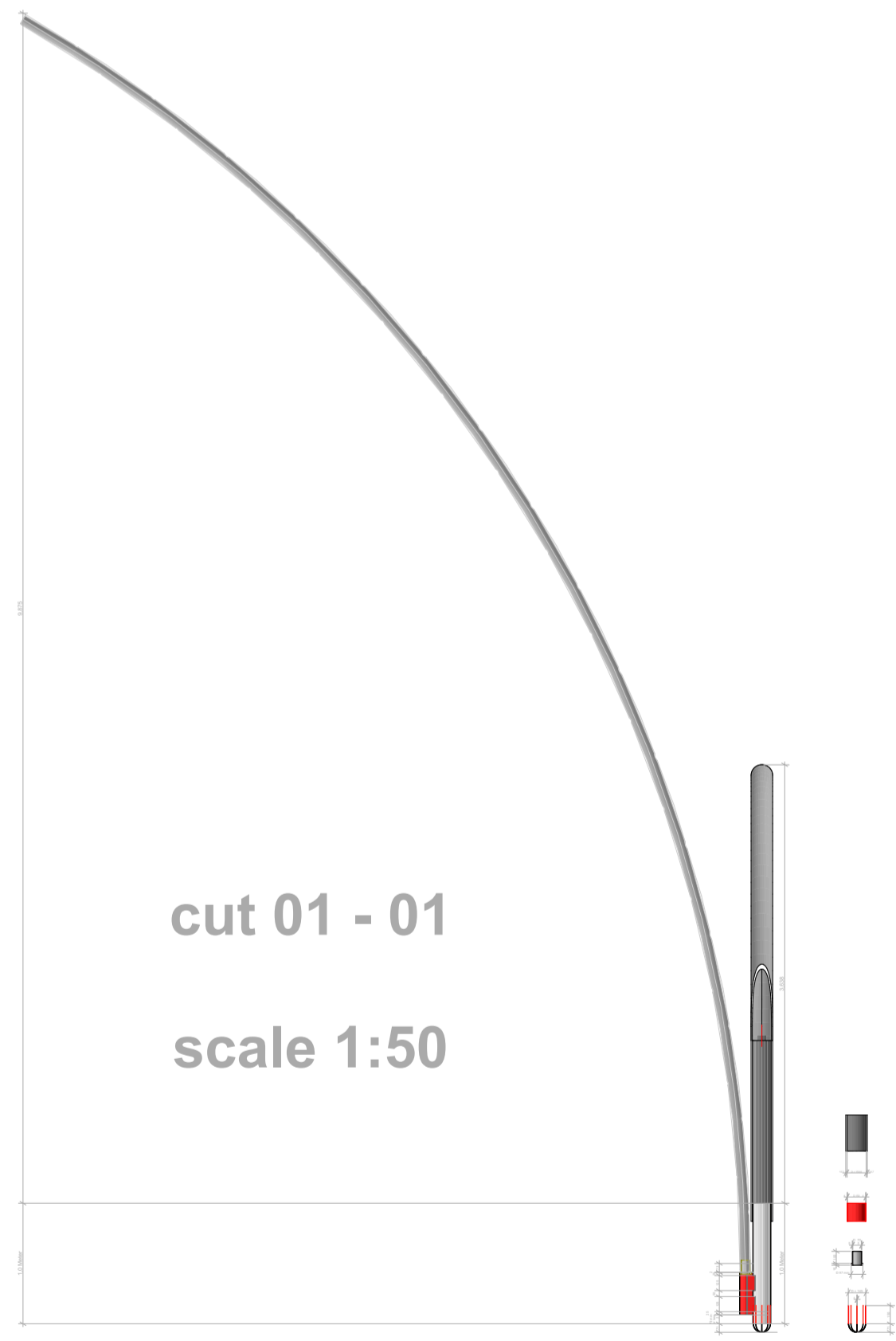
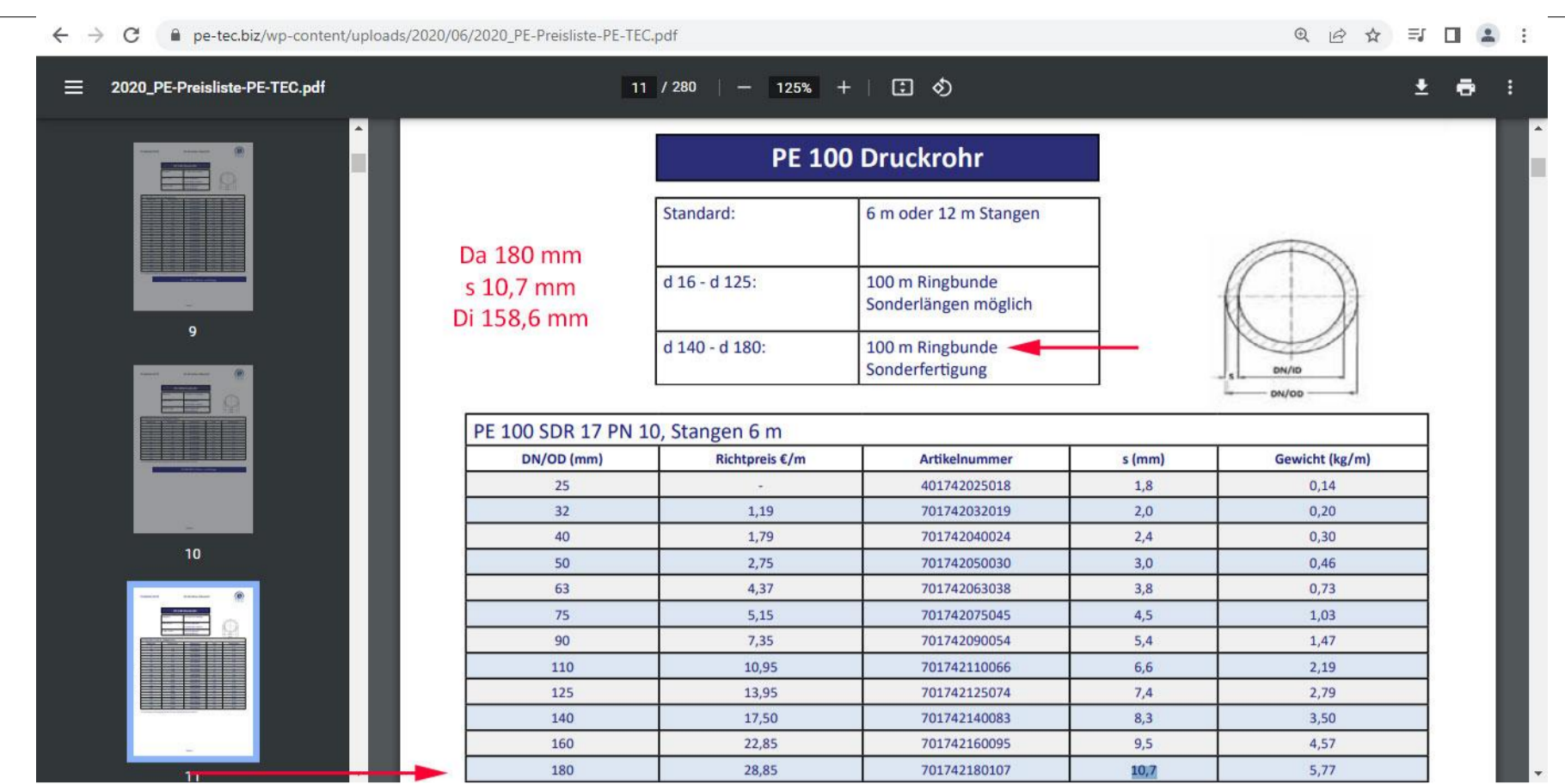
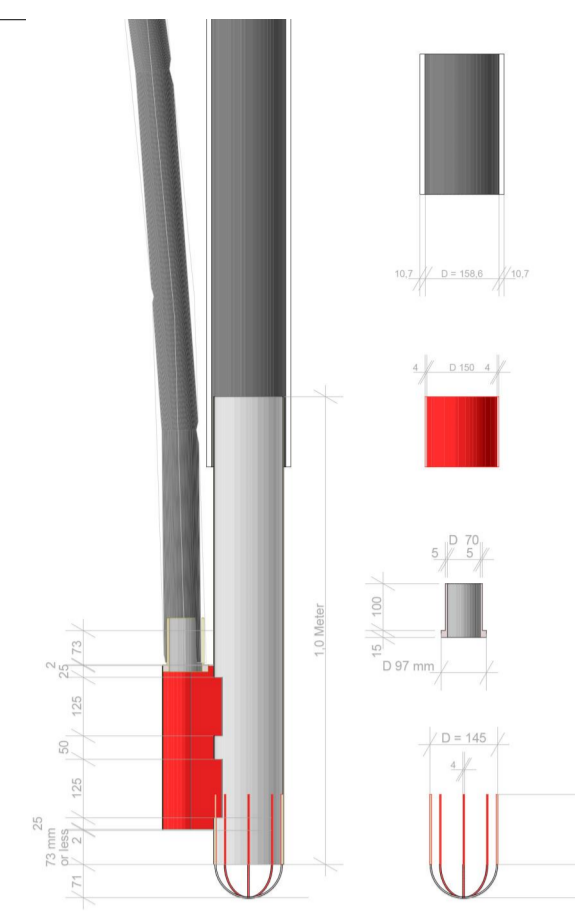

cut 01 - 01

scale 1:50

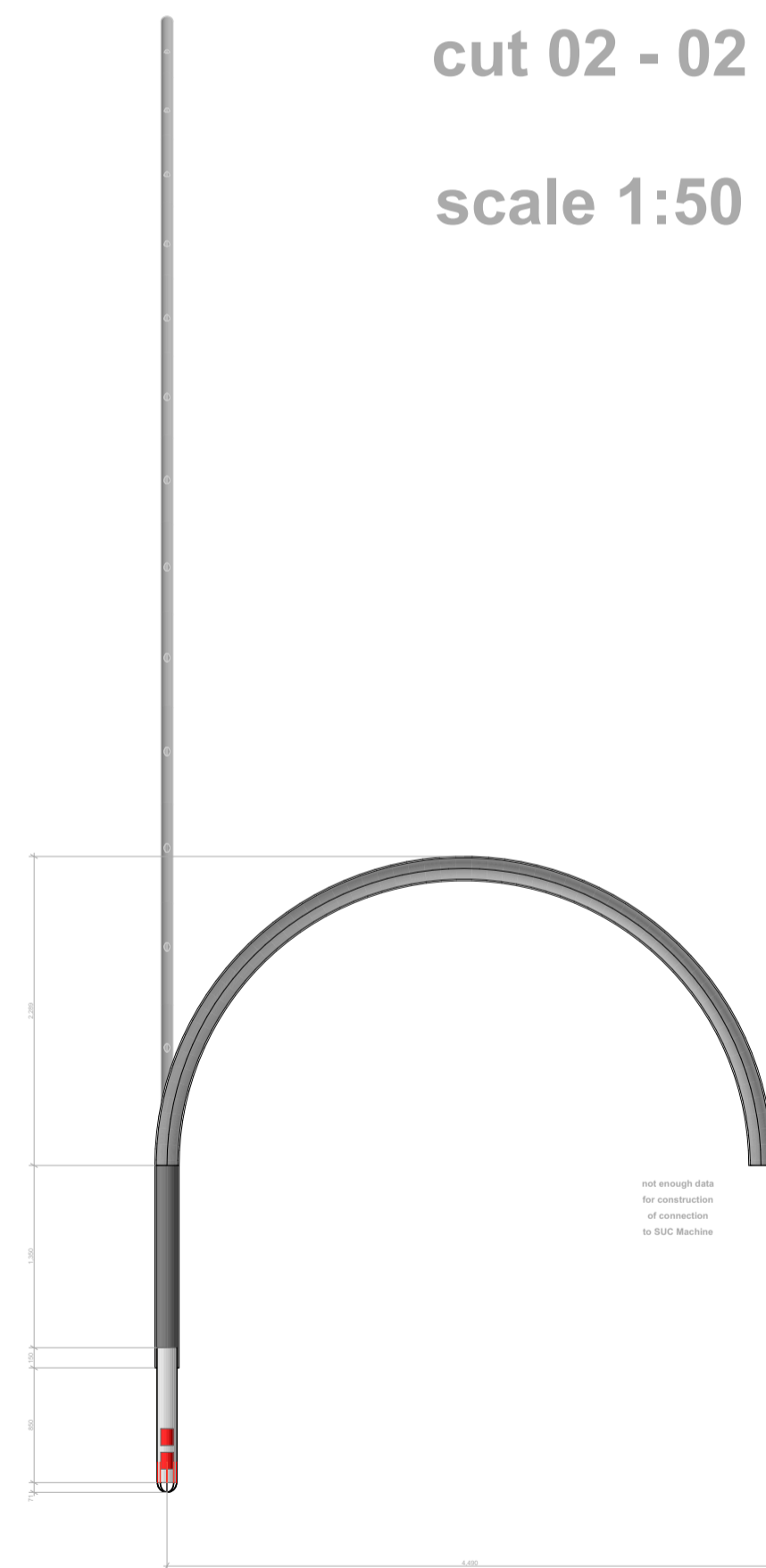

cut 02 - 02

scale 1:50

90 ° from
above

scale 1:20

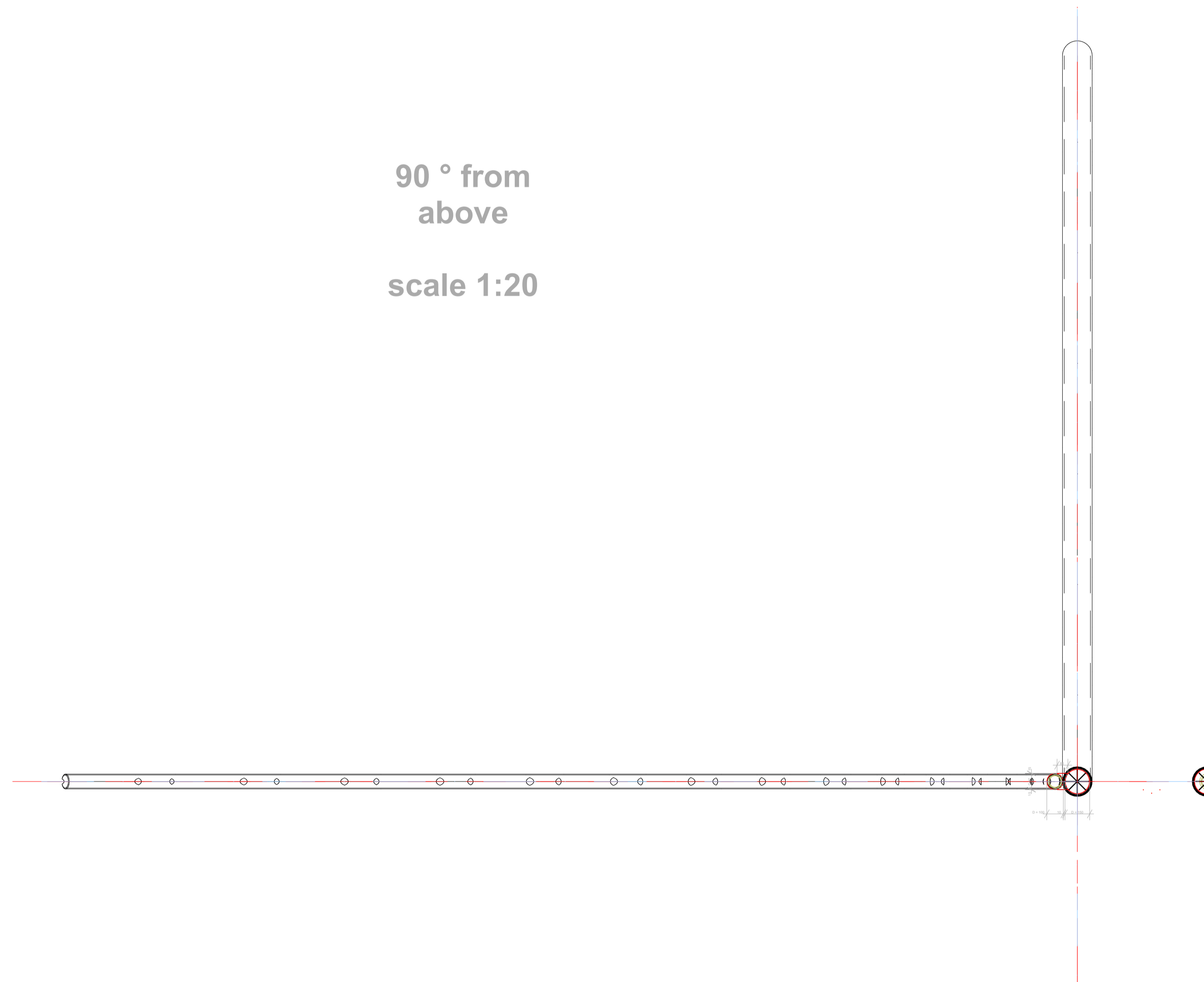

Zoom into these 3 - that is CAAD Data - that is not pictures - best regards Ing. Goebel

RevID	CHD	Change Name	Date

Company Title



Ingenieurbüro Goebel

Air-Intake NEW

for Kongskilde SUC 1000 E SU

Drawing Status

Draft

Modified by

Ing. Goebel

Date

16.06.2022

Checked by

Date

Drawing Scale

many - all to scale

Layout ID